

43338

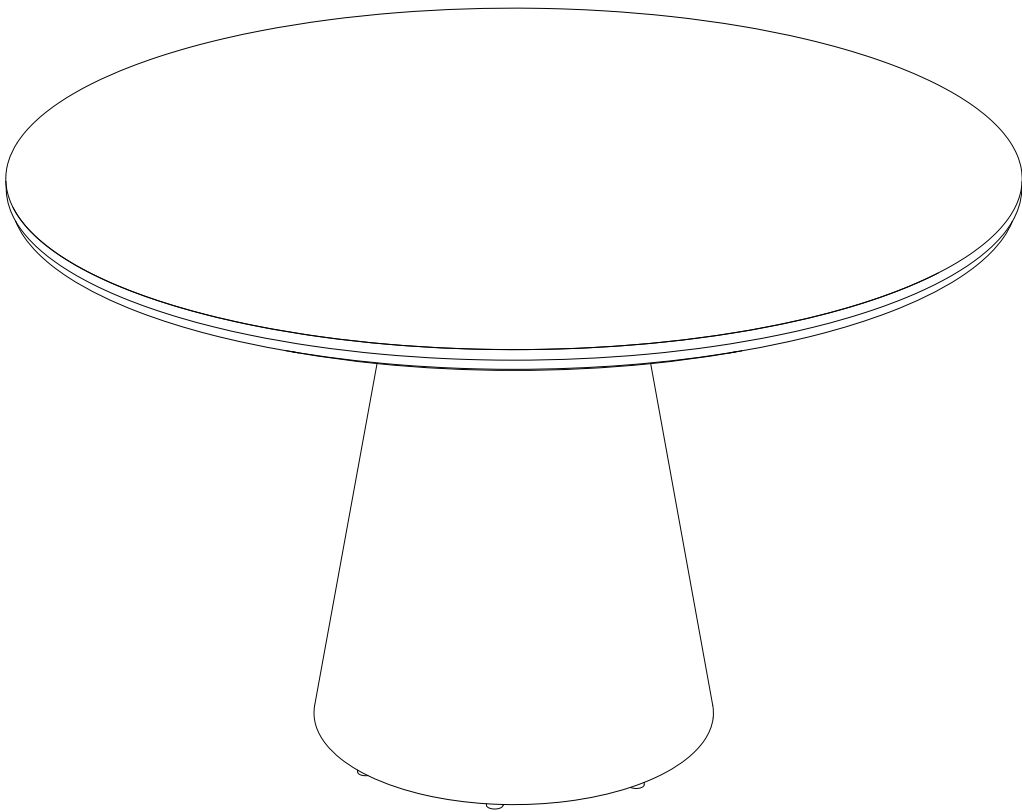

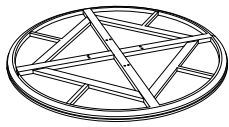

A x1

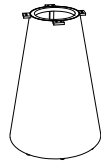

B x1



C x1

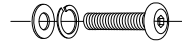

AA x8



BB x1

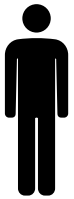

X2

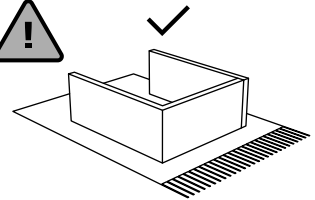
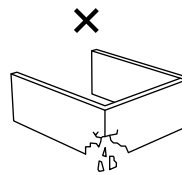

1

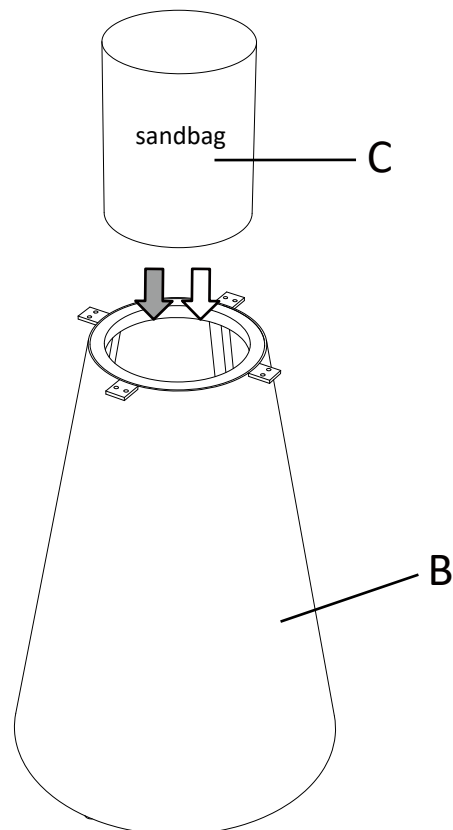

2

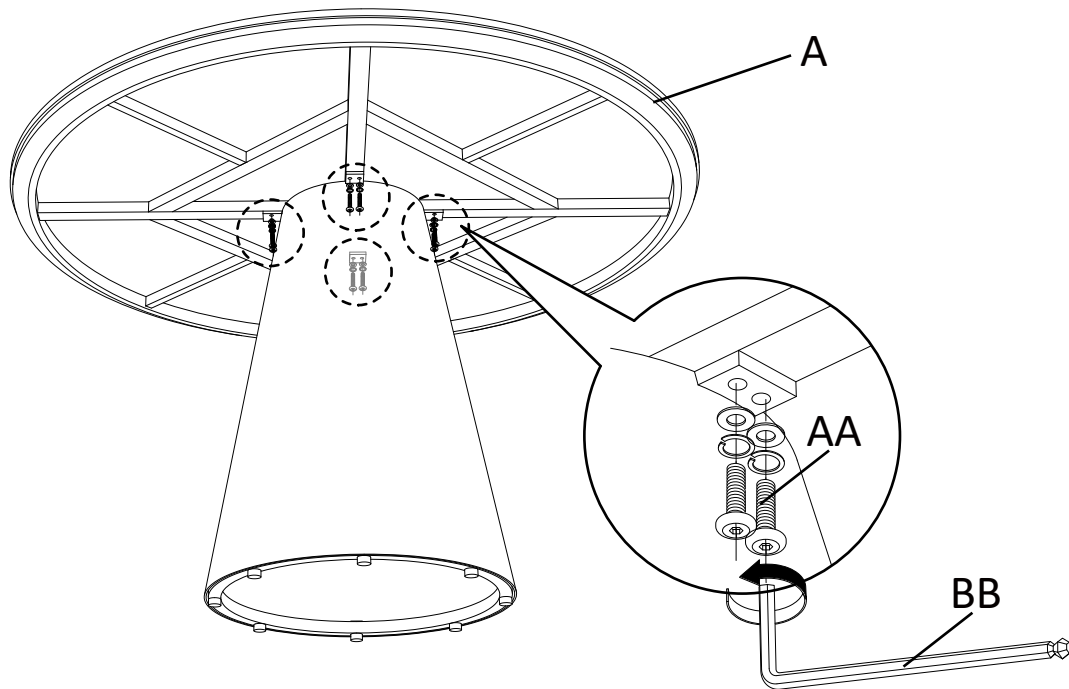
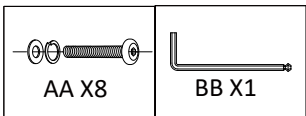

50%

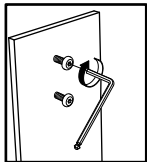

3

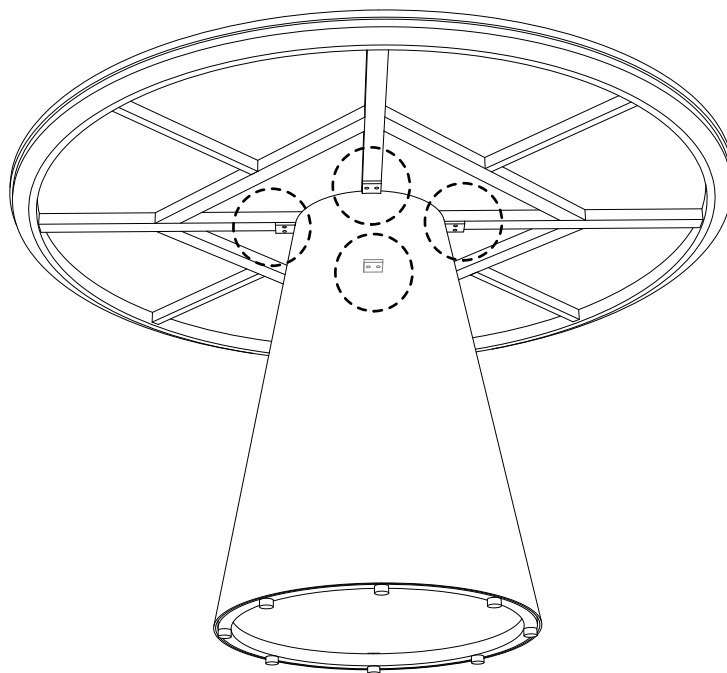
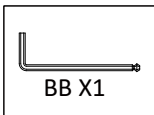

100%

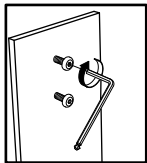

4

